

*Single switch
with Series diode
MOSFET Power Module*

$V_{DSS} = 1000V$
 $R_{DSon} = 65m\Omega$ typ @ $T_j = 25^\circ C$
 $I_D = 145A$ @ $T_c = 25^\circ C$

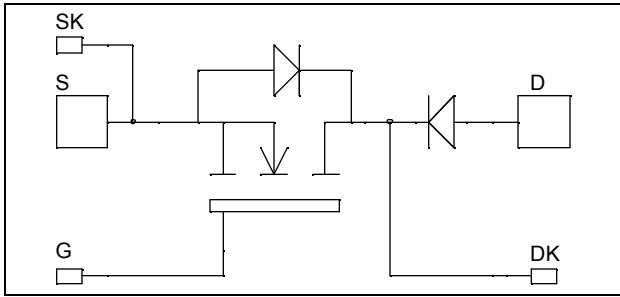

Application

- Zero Current Switching resonant mode

Features

- Power MOS 7[®] MOSFETs
 - Low R_{DSon}
 - Low input and Miller capacitance
 - Low gate charge
 - Avalanche energy rated
 - Very rugged
- Kelvin source for easy drive
- Very low stray inductance
 - Symmetrical design
 - M5 power connectors
- High level of integration
- AlN substrate for improved thermal performance

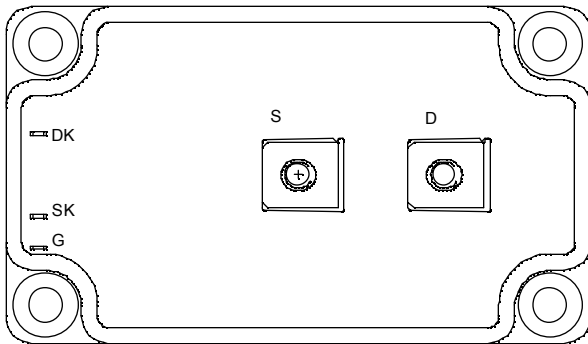

Benefits

- Outstanding performance at high frequency operation
- Direct mounting to heatsink (isolated package)
- Low junction to case thermal resistance
- Low profile
- RoHS Compliant

Absolute maximum ratings

Symbol	Parameter	Max ratings	Unit
V_{DSS}	Drain - Source Breakdown Voltage	1000	V
I_D	Continuous Drain Current	$T_c = 25^\circ C$	145
		$T_c = 80^\circ C$	110
I_{DM}	Pulsed Drain current	580	A
V_{GS}	Gate - Source Voltage	± 30	V
R_{DSon}	Drain - Source ON Resistance	78	$m\Omega$
P_D	Maximum Power Dissipation	$T_c = 25^\circ C$	3250
I_{AR}	Avalanche current (repetitive and non repetitive)	30	A
E_{AR}	Repetitive Avalanche Energy	50	mJ
E_{AS}	Single Pulse Avalanche Energy	3200	

CAUTION: These Devices are sensitive to Electrostatic Discharge. Proper Handling Procedures Should Be Followed. See application note APT0502 on www.microsemi.com

All ratings @ $T_j = 25^\circ\text{C}$ unless otherwise specified

Electrical Characteristics

Symbol	Characteristic	Test Conditions	Min	Typ	Max	Unit
I_{DSS}	Zero Gate Voltage Drain Current	$V_{GS} = 0\text{V}, V_{DS} = 1000\text{V}$			400	μA
		$V_{GS} = 0\text{V}, V_{DS} = 800\text{V}$			2	mA
$R_{DS(on)}$	Drain – Source on Resistance	$V_{GS} = 10\text{V}, I_D = 72.5\text{A}$		65	78	$\text{m}\Omega$
$V_{GS(th)}$	Gate Threshold Voltage	$V_{GS} = V_{DS}, I_D = 20\text{mA}$	3		5	V
I_{GSS}	Gate – Source Leakage Current	$V_{GS} = \pm 30\text{V}, V_{DS} = 0\text{V}$			± 400	nA

Dynamic Characteristics

Symbol	Characteristic	Test Conditions	Min	Typ	Max	Unit
C_{iss}	Input Capacitance	$V_{GS} = 0\text{V}$		28.5		nF
C_{oss}	Output Capacitance	$V_{DS} = 25\text{V}$		5.08		
C_{rss}	Reverse Transfer Capacitance	$f = 1\text{MHz}$		0.9		
Q_g	Total gate Charge	$V_{GS} = 10\text{V}$		1068		nC
Q_{gs}	Gate – Source Charge	$V_{Bus} = 500\text{V}$		136		
Q_{gd}	Gate – Drain Charge	$I_D = 145\text{A}$		692		
$T_{d(on)}$	Turn-on Delay Time	$V_{GS} = 15\text{V}$		18		ns
T_r	Rise Time	$V_{Bus} = 500\text{V}$		14		
$T_{d(off)}$	Turn-off Delay Time	$I_D = 145\text{A}$		140		
T_f	Fall Time	$R_G = 0.75\Omega$		55		
E_{on}	Turn-on Switching Energy	Inductive switching @ 25°C		4.8		mJ
E_{off}	Turn-off Switching Energy	$V_{GS} = 15\text{V}, V_{Bus} = 670\text{V}$ $I_D = 145\text{A}, R_G = 0.75\Omega$		2.9		
E_{on}	Turn-on Switching Energy	Inductive switching @ 125°C		8		mJ
E_{off}	Turn-off Switching Energy	$V_{GS} = 15\text{V}, V_{Bus} = 670\text{V}$ $I_D = 145\text{A}, R_G = 0.75\Omega$		3.9		

Series diode ratings and characteristics

Symbol	Characteristic	Test Conditions	Min	Typ	Max	Unit
V_{RRM}	Maximum Peak Repetitive Reverse Voltage		1000			V
I_{RM}	Maximum Reverse Leakage Current	$V_R = 1000\text{V}$	$T_j = 25^\circ\text{C}$		750	μA
			$T_j = 125^\circ\text{C}$		1000	
I_F	DC Forward Current	$T_c = 80^\circ\text{C}$		240		A
V_F	Diode Forward Voltage	$I_F = 240\text{A}$		2	2.5	V
		$I_F = 480\text{A}$		2.2		
		$I_F = 240\text{A}$	$T_j = 125^\circ\text{C}$	1.7		
t_{rr}	Reverse Recovery Time	$I_F = 240\text{A}$ $V_R = 667\text{V}$ $di/dt = 800\text{A}/\mu\text{s}$	$T_j = 25^\circ\text{C}$	280		ns
	$T_j = 125^\circ\text{C}$		350			
Q_{rr}	Reverse Recovery Charge		$T_j = 25^\circ\text{C}$	3.04		μC
			$T_j = 125^\circ\text{C}$	14.4		

Thermal and package characteristics

Symbol Characteristic

			Min	Typ	Max	Unit
R _{thJC}	Junction to Case Thermal Resistance	Transistor			0.038	°C/W
		Series diode			0.23	
V _{ISOL}	RMS Isolation Voltage, any terminal to case t = 1 min, I _{isol} < 1mA, 50/60Hz		2500			V
T _J	Operating junction temperature range		-40		150	°C
T _{STG}	Storage Temperature Range		-40		125	
T _C	Operating Case Temperature		-40		100	
Torque	Mounting torque	To Heatsink	M6	3	5	N.m
		For terminals	M5	2	3.5	
Wt	Package Weight				280	g

SP6 Package outline (dimensions in mm)

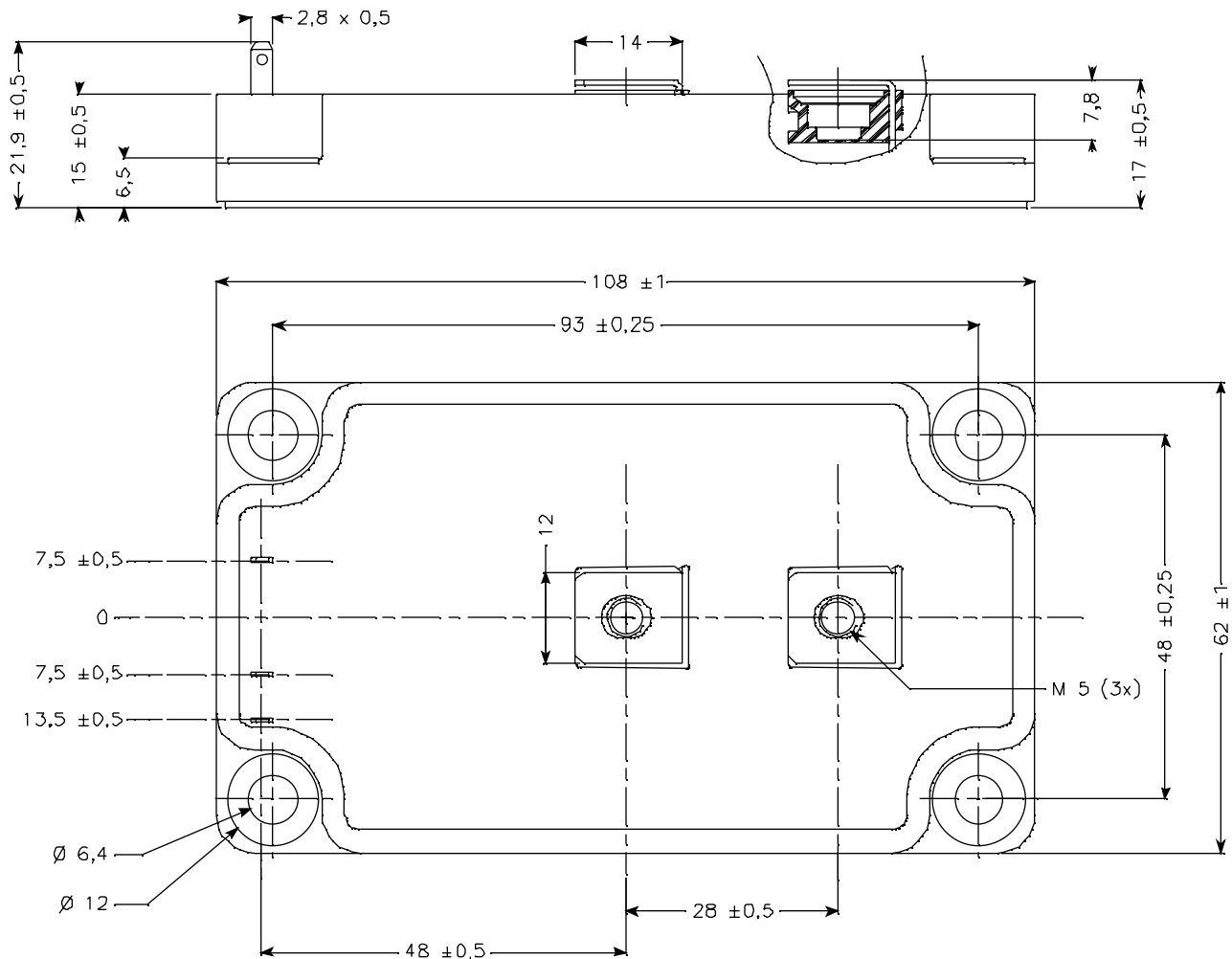

See application note APT0601 - Mounting Instructions for SP6 Power Modules on www.microsemi.com

Typical Performance Curve

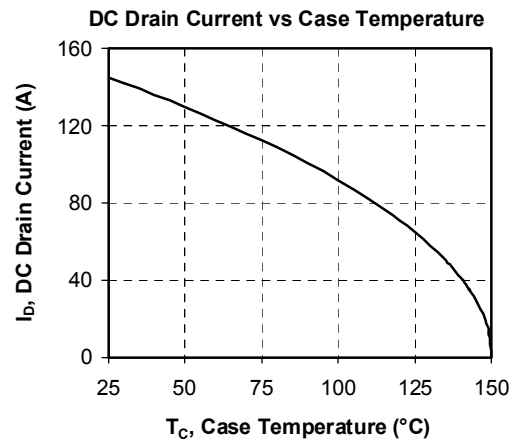
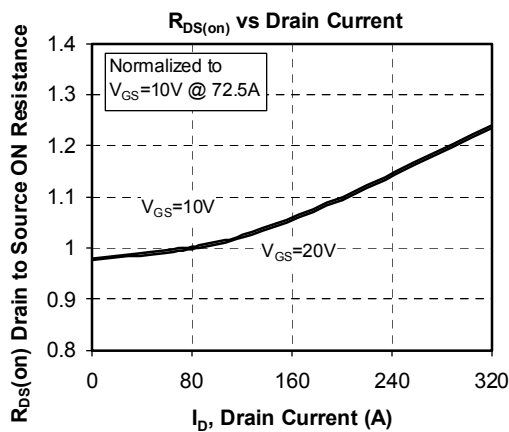
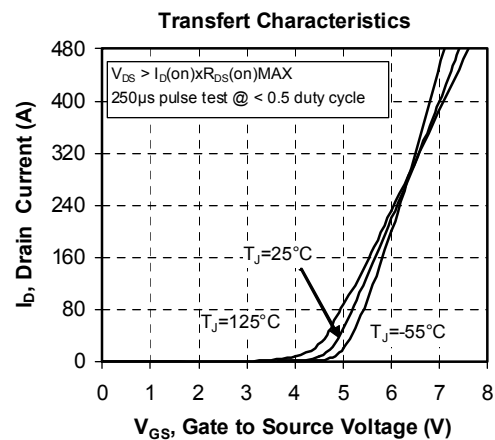
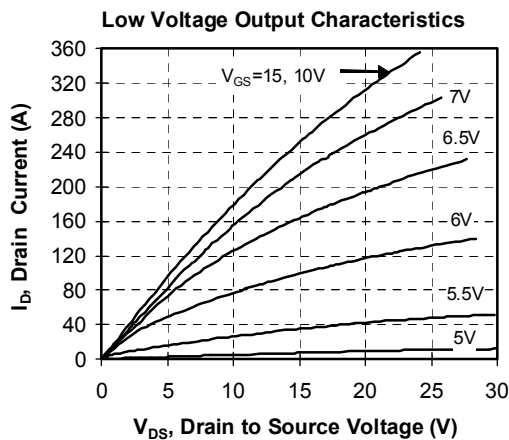
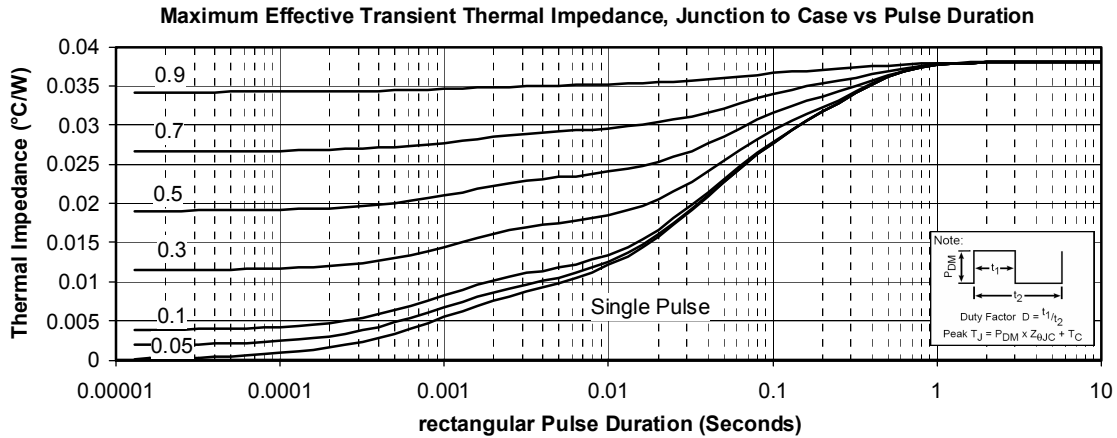

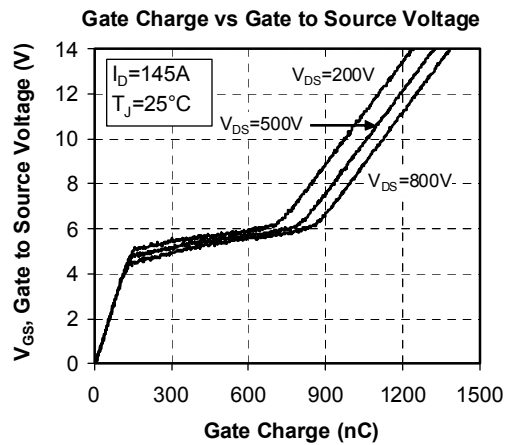
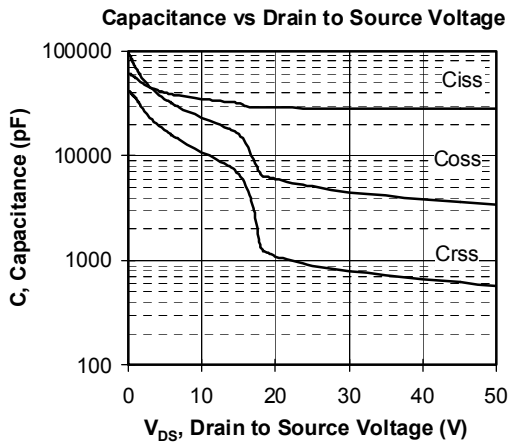
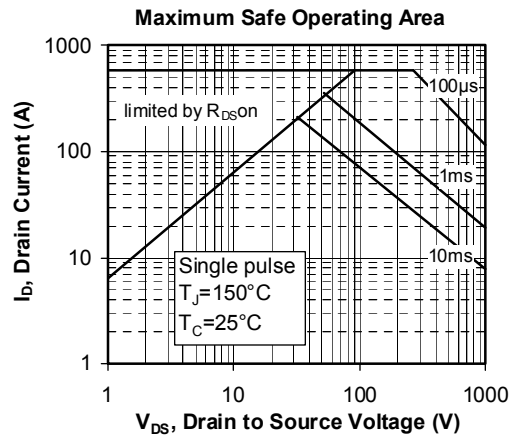
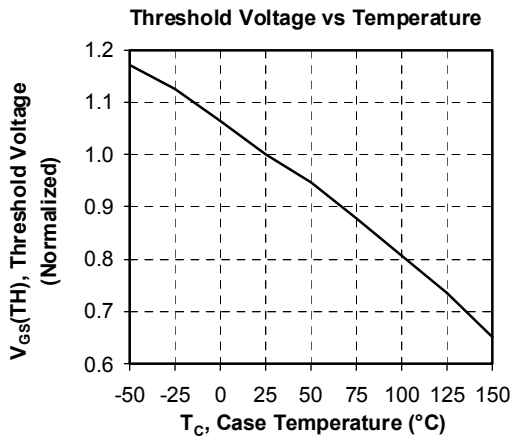
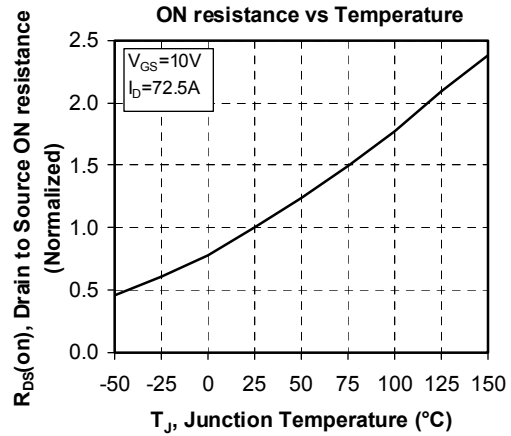
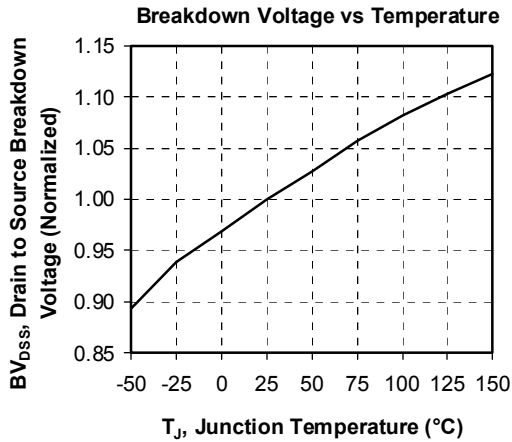

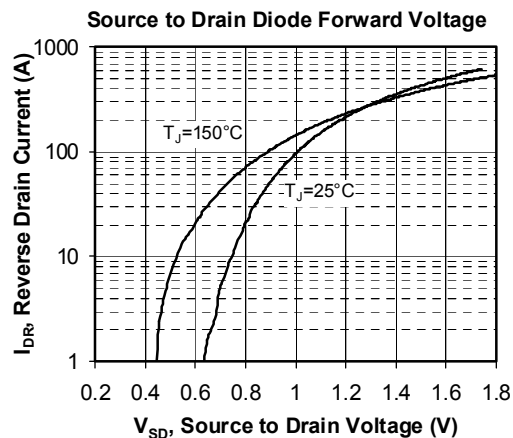
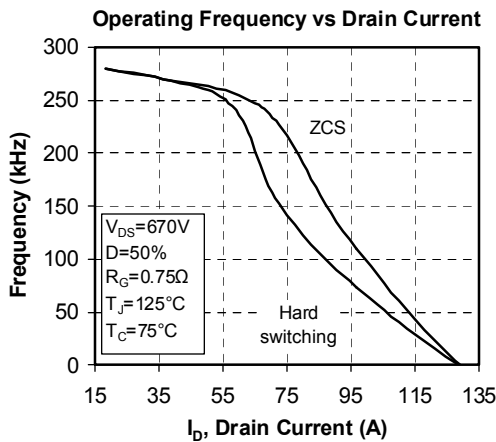
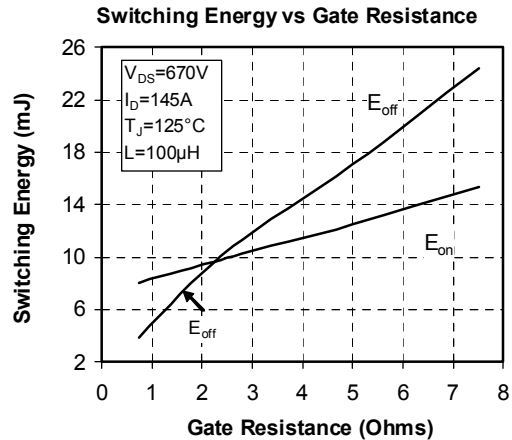
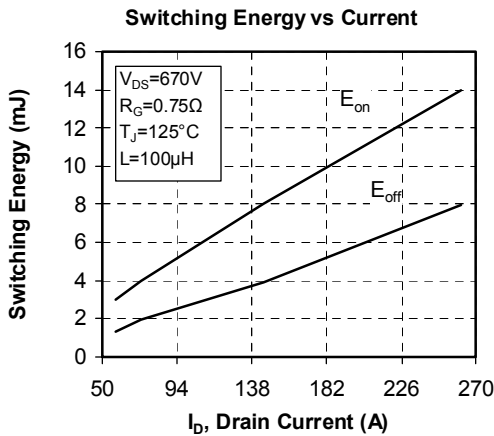
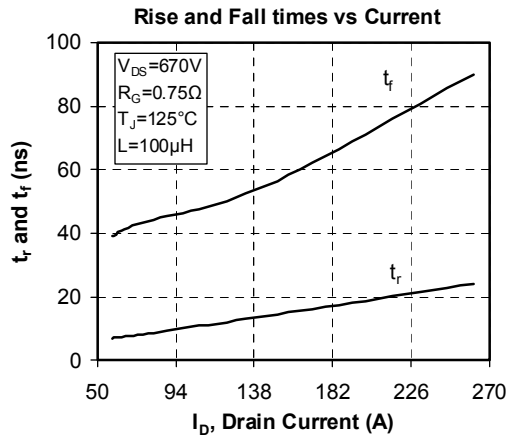
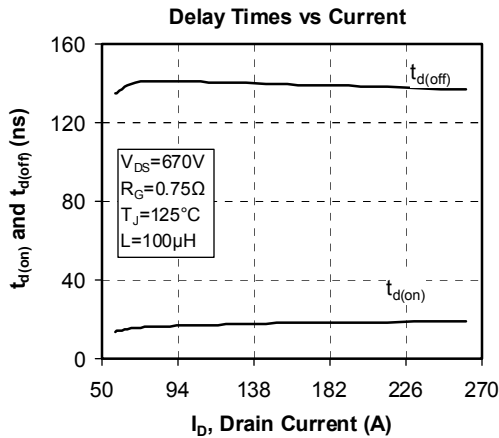

Microsemi reserves the right to change, without notice, the specifications and information contained herein

Microsemi's products are covered by one or more of U.S. patents 4,895,810 5,045,903 5,089,434 5,182,234 5,019,522 5,262,336 6,503,786 5,256,583 4,748,103 5,283,202 5,231,474 5,434,095 5,528,058 and foreign patents. U.S. and Foreign patents pending. All Rights Reserved.